

# Tire & Wheel Tools & Supplies

INDEX

PAINT

HANDLEBARS

STREET LEVERS

FORK SEALS

CABLES

SUSPENSION

ELECTRICAL

FILTERS

BRAKE LINES

BRAKES

CABLE MAKING SUPPLIES

CONTROLS

DUAL SPORT

MANUALS

F50 PRODUCTS

EMGO

DRIVE

DISPLAY

JETS

BEARINGS

EYEWEAR

VINTAGE

MIRRORS

EUROPEAN

KICKERS

SHIFTERS

MISC

HARD PARTS

SHOP TOOLS

CHEMICALS

TOOLS

## Wheel Truing, Balancing Stand & Accessories

560-90003

Wheel Truing stand Only. Does not include bearings shown at top of photo

560-90004

Truing and balancing stand includes bearings at top of photo which roll with much less resistance than wheel bearings (no seal drag)

560-90010

Bearing kit to convert truing stand into balancing stand

560-90304

Replacement wheel center for truing stand. (The pointed thing that slips out)

## Spoke Wrench

560-90002

Six of the most popular sizes all on one wrench. Extra thick for a longer bearing on the nipple flats than other wrenches. Avoids "Round Off" of nipples.



243-01015

Accu-Gage precision 0-15 PSI bronze bourdon tube full geared brass movement pressure gauge with angle chuck

243-01060

Accu-Gage 0-60 gauge with angle chuck



243-02015

Accu-Gage 0-15 gauge with 14" hose and angle chuck. Push button valve release excess air to exact pressure

243-02060

Accu-Gage 0-60 gauge with 14" hose and angle chuck

243-02062

Accu-Gage 0-60 gauge with 14" hose and right angle chuck



243-03001

Rubber shock absorber cover, fits all four gauges above.



Rev. 03-15-06

## “MP” “Metric” Tool

### 121-08161

- The “MP” (Multi-Purpose) Tool is the perfect addition to your fanny pack
- The versatile tool is a must-have for on-the-trail repairs or adjustments
- Can be used to remove 8mm, 10mm, 12mm & 14mm bolts, #2 & #3 Phillips screws, small & medium straight-slot screws and 5 & 6 mm hex bolts
- Includes a 1/4” & 3/8” socket driver for using the 10mm & 12mm sockets included with the tool
- Tool can be enhanced by adding your own 1/4” - or 3/8”-drive socket attachments
- Includes convenient carrying case
- Replacement pieces sold separately



## Replacement Parts

**121-08162** #2 & #3 phillips bit

**121-08163** 5mm & 6mm hex bit

**121-08164** small & medium

## Spoke Wrenches

- Chrome-vanadium tool steel with satin-chrome finish
- Square-end openings which grip the spoke nipple on all four sides
- Offset slotted ends make it easy and quick to use
- 6mm and 6.3mm for most Japanese dirt & street bikes
- 6.5mm and 6.8mm for most European dirt bikes

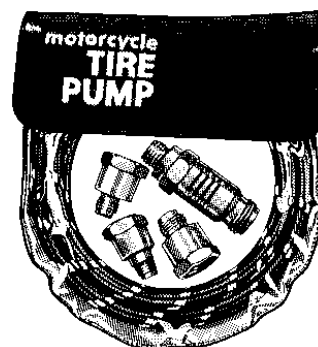

**401-97600** Motorcycle engine tire pump. Fits 10, 12, 14 & 18mm spark plug holes. Special valving and air intake parts ensure clean outside air pumped into tire. Kit contains 42” hose, pump and adaptors.

**401-97602** Replacement hose 72” long.

INDEX

PAINT

HANDLEBARS

STREET LEVER

FORK SEALS

CABLES

SUSPENSION

ELECTRICAL

FILTERS

BRAKE LINES

BRAKES

CABLE MAKING SUPPL

CONTROLS

DUAL SPORT

MANUALS

F50 PRODUCTS

EMGO

DRIVE

DISPLAY

JETS

BEARINGS

EYEWEAR

VINTAGE

MIRRORS

EUROPEAN

KICKERS

SHIFTERS

MISC

HARD PARTS

SHOP TOOLS

CHEMICALS

TOOLS

# Tire & Wheel Tools & Supplies

INDEX

PAINT

HANDLEBARS

STREET LEVERS

FORK SEALS

CABLES

SUSPENSIO

ELECTRICAL

FILTERS

BRAKE LINES

BRAKES

CABLE MAKING

CONTROL

DUAL SPORT

MANUAL

FSO PRODUCT

EMGO

DRIVE

DISPLAY

JETS

BEARINGS

EYEWEAR

VINTAGE

MIRRORS

EUROPEAN

KICKERS

SHIFTERS

MISC

HARD PARTS

SHOP TOOLS

CHEMICALS

TOOLS

## Coats 220 Cyclor & Parts

### Coats Tire Changer

551-00220

Tire Changer with 8" to 14" rim clamps for ATC vehicles and 14" to 23" diameter rim clamps for motorcycles. A motorcycle tire changer that is so simple to use & makes changing of motorcycle tires so much easier and faster. This manually operated unit will handle regular spoke wheels and the new custom alloy wheels. Tubeless or tube type tires. Designed & built in the USA by the world's largest manufacturer of tire changers. Built to provide years of service.



### Camel Stuff Tire Mounting Lubricant 289-12095

8 pound pail. Makes tire mounting and dismounting easier. Stops rubber squeaks. Contains rust inhibitor. Makes 5 gallons of lubricant when mixed with water.



### 293-00072

Rubber lubricant for mounting & dismounting tires. 15 fluid oz. of concentrate, makes 1 gallon of solution.



### Replacement Parts for 220 Cyclor

- |           |  |
|-----------|--|
| 551-07043 | 13- Rim clamp adjustment screw   |
| 551-01181 | 14 - Roll pin for clamp screw  |
| 551-01017 | 15 - Roll pin for screw handle   |
| 551-07090 | 16 - Handle for clamp screw  |
| 551-07091 | 17 - Grip for handle   |
| 551-01253 | 18 - Bushing for screw   |
| 551-07560 | 21 - Slotted nut for clamp   |
| 551-07559 | 22 - Adjustable rim clamp motorcycle   |
| 551-07158 | 23 - Stationary rim clamp motorcycle   |
| 551-07034 | 24 - Table top   |
| 551-07562 | 25 - Adjustable rim clamp ATC  |
| 551-07049 | 26 - Stationary rim clamp ATC  |
| 551-07063 | 27 - Vertical pivot tube   |
| 551-07064 | 29 - Locking knob  |
| 551-06259 | 35 - Lube bottle   |
| 551-00491 | 37 - Lube applicator   |
| 551-07423 | 39 - Tire iron protectors (pair)   |
| 551-07156 | 40 - Big tire iron   |
| 551-07424 | 41 - Rim clamp protectors (6)  |
| 551-08360 | ATV bead breaker kit with longer arm for more leverage and smaller shoe to fit small wheels. |

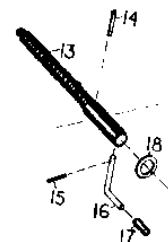
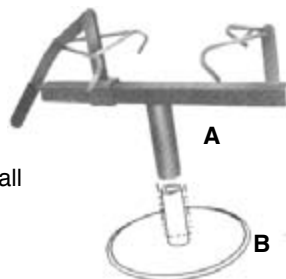
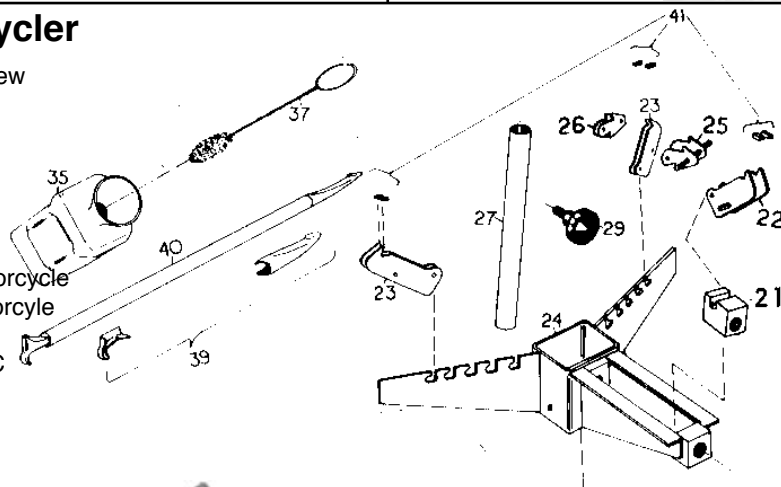

Other accessories for the Coats Rim Tire Changer

- | Part #       | Description   |
|--------------|---------------|
| B) 551-81329 | Bench Adaptor |
| A) 551-08028 | Tire Spreader |

# Tire & Wheel Tools & Supplies

## Clip-On Wheel Weights

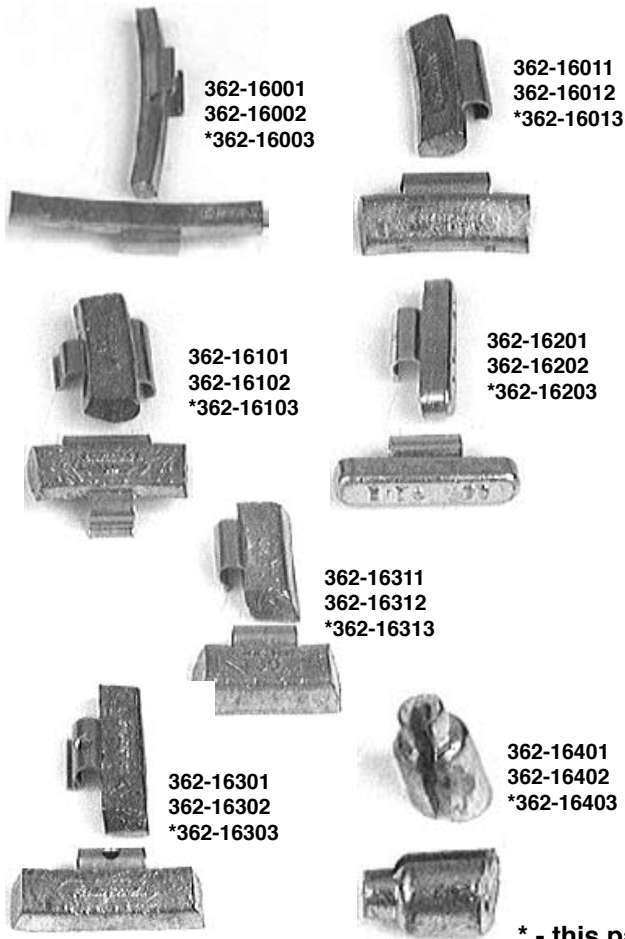

362-16001  
362-16002  
\*362-16003

362-16011  
362-16012  
\*362-16013

362-16101  
362-16102  
\*362-16103

362-16201  
362-16202  
\*362-16203

362-16311  
362-16312  
\*362-16313

362-16301  
362-16302  
\*362-16303

362-16401  
362-16402  
\*362-16403

CLIP-ON WHEEL WEIGHTS			
SOLD IN PACKS OF FIVE			
PART #	GRAMS	MAKE	O.E.M. NO.
362-16001	10g	HONDA	42705-MJ0-000
362-16002	20g	HONDA	42706-MJ0-000
362-16003	30g	HONDA	42707-MJ0-000
362-16011	10g	HONDA KAWASAKI	42705-MB0-000 41075-1011/1004
362-16012	20g	HONDA KAWASAKI	42706-MB0-000 41075-1012/1005
362-16013	30g	HONDA KAWASAKI	42707-MB0-000 41075-1013/1006
362-16101	10g	KAWASAKI	41075-1051/1014
362-16102	20g	KAWASAKI	41075-1052/1015
362-16103	30g	KAWASAKI	41075-1053/1016
362-16201	10g	SUZUKI SUZUKI	55411-45100 55411-00A00
362-16202	20g	SUZUKI SUZUKI	55412-46100 55412-00A00
362-16203	30g	SUZUKI SUZUKI	55413-46100 55413-00A00
362-16301	10g	YAMAHA	29L-25398-00
362-16302	20g	YAMAHA	29L-25398-10
362-16303	30g	YAMAHA	29L-25398-20
362-16311	10g	YAMAHA	1A1-25399-00
362-16312	20g	YAMAHA	1A1-25399-01
362-16313	30g	YAMAHA	2M0-25399-00
362-16401	10g	SPOKE	UNIVERSAL
362-16402	20g	SPOKE	UNIVERSAL
362-16403	30g	SPOKE	UNIVERSAL

\* - this part no. shown

### Bead Expander

289-18287

For tubeless tires, air operated, withstands 200 lbs. of pressure



### Adhesive Wheel Weights

121-08064

Adhesive backed wheel weights, box of 30 strips.  
(360 segments total)  
1/2" x 6" long scored every 1/2"

1/4OZ	1/4OZ	1/4OZ	1/4OZ	1/4OZ	1/4OZ
7gm	7gm	7gm	7gm	7gm	7gm

121-08046

Adhesive backed wheel weights. card contains 6 strips of 12 1/4oz. segments  
(72 segments total)

560-90013

Standard Tape-A-Weight; 15 pieces, 3/8" wide x 12" long scored every 1/2". 1/2" segment weighs 1/4 ounce.

560-99405

Chrome Tape-A-Weight. Box of 12 pieces; 1/2" x 12" scored every 1/2" with smooth finish. (144 segments)



Rev. 03-15-06

(626) 792-7384  
www.FlandersCompany.com



Fax: (626) 792-5341  
www.FlandersCo.com

INDEX

PAINT

HANDLEBARS

STREET LEVER

FORK SEALS

CABLES

SUSPENSION

ELECTRICAL

FILTERS

BRAKE LINES

BRAKES

CABLE MAKING SUPPL

CONTROLS

DUAL SPORT

MANUALS

FSO PRODUCTS

EMGO

DRIVE

DISPLAY

JETS

BEARINGS

EYEWEAR

VINTAGE

MIRRORS

EUROPEAN

KICKERS

SHIFTERS

MISC

HARD PARTS

SHOP TOOLS

CHEMICALS

TOOLS

45

# Tire & Wheel Tools & Supplies

## Tire Repair Tools & Accessories

### Camel



289-17236

Special yellow marking crayon for tires & tubes.

Boxes of Chembond cold patches

289-14152

1 5/8" dia.

Box of 40



289-14153

2 1/4" dia.

Box of 30

**Camel Liquid Buffer** thoroughly cleans surface of tube prior to applying patch.

289-12092

Quart can

289-12093

14 oz. aerosol can



289-17250

One lb. dispenser can of tire talc.



### UNIVERSAL CEMENT



289-12077

2 oz. tube

289-12085

4 oz. brush top can.

321-36008

(11gr.) tube "not camel brand"

289-15169

Tubeless tire repair kit, great for ATC vehicles



289-11049

Rectangular box containing 10 sq. in. rubber, 3 bevel patches 1" x 1", cement & buffer



289-17237

Small buffer sticher

289-17244

Shop size sticher for tube patching.

INDEX

PAINT

HANDLEBARS

STREET LEVERS

FORK SEALS

CABLES

SUSPENSION

ELECTRICAL

FILTERS

BRAKE LINES

BRAKES

CABLE MAKING SUPPLIES

CONTROLS

DUAL SPORT

MANUALS

FSO PRODUCTS

EMGO

DRIVE

DISPLAY

JETS

BEARINGS

EYEWEAR

VINTAGE

MIRRORS

EUROPEAN

KICKERS

SHIFTERS

MISC

HARD PARTS

SHOP TOOLS

CHEMICALS

TOOLS

Rev. 03-15-06

# Tire & Wheel Tools & Supplies

## Tire Repair Tools & Accessories



### Valve Core Extracting Tools

289-41469

All metal construction. Screwdriver simplifies installation and removal of standard valve cores.



### Super Grip Probe

289-15225

For professionals to clean and prepare injury. Use with Universal Cement to promote vulcanization.

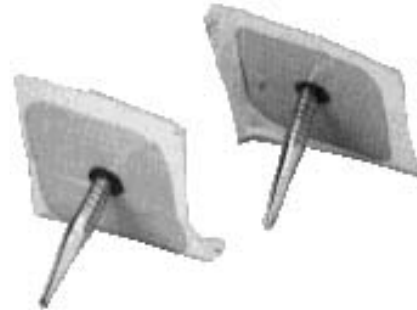

### Plug-N-Patch

Made for all tires, including steel belted radial. Fills the puncture. Seals the injury. Chemically vulcanizing. In some cases no need to remove tire.

**289-15290** Sm. Reinforced Plug-N-Patch For Box:Order15. Up to 1/8" Puncture  
**289-15291** Med. Reinforced Plug-N-Patch For Box:Order 10. For 1/4" Puncture.

INDEX

PAINT

HANDLEBARS

STREET LEVER

FORK SEALS

CABLES

SUSPENSION

ELECTRICAL

FILTERS

BRAKE LINES

BRAKES

CABLE MAKING SUPPL

CONTROLS

DUAL SPORT

MANUALS

FSO PRODUCTS

EMGO

DRIVE

DISPLAY

JETS

BEARINGS

EYEWEAR

VINTAGE

MIRRORS

EUROPEAN

KICKERS

SHIFTERS

MISC

HARD PARTS

SHOP TOOLS

CHEMICALS

TOOLS



### Tubeless Tire Valve Inserting Tool

289-41506

For installing rubber snap-in valves. Will also remove old valves.

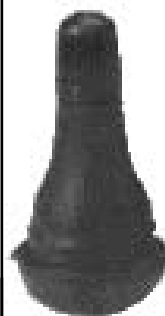

289-30415



289-30412

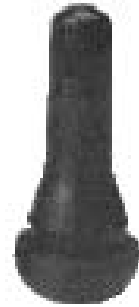

289-30413

### Tubeless Snap-In Tire Valves

Conventional snap-in tire valves complete with valve core and black plastic dust cap. They are manufactured to original equipment standards. The rubber used for these valves is resistant to ozone damage. **IMPORTANT: Tires with snap-in valves should not exceed a cold inflation pressure of 60 P.S.I. Do not use in rims that exceed .156" in thickness.**

Valves for .625" diameter Rim Holes

289-30415 1-1/4"

Valves for .453" diameter Rim Holes

289-30412 7/8"

289-30413 1-1/4"



557-00944

Stem extender for air shock

401-68508

1-7 PSI 4" Long Pencil type tire pressure gauge w.key chain

557-00905

Pencil type tire pressure gauge 5-50 PSI range

557-00906

Low pressure pencil type tire pressure gauge. 0-16 PSI range.



Rev. 03-15-06

(626) 792-7384  
www.FlandersCompany.com



Fax: (626) 792-5341  
www.FlandersCo.com

47

# Tire & Wheel Tools & Supplies

## Tire Repair Accessories

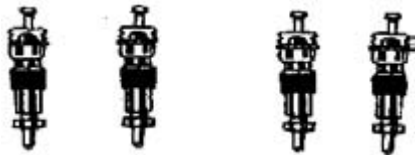

**289-38791**  
Package of four std. valve cores.



**289-38601**  
Package of four valve caps with stem remover.

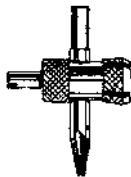

**289-41067**  
Valve stem and core repair tool.  
Removes valve cores and repairs fouled up threads.



**PJ1 Balance Plus**  
**445-02180** 8 oz. Bottle  
Liquid tire balancer & sealant

**289-30450**  
Valve stem clamp in chrome plated, for tubeless tire wheels. Fits .453" or .625" diameter rim holes.  
**289-30468**  
Replacement gaskets for above (5- .453" & 5- .625")



**531-01202**  
Motorcycle Tire Pressure Monitors and Valve Caps.

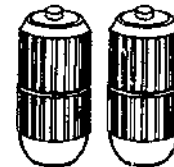

**293-00437**  
Valve stem, clamp in. Fits .327" diameter rim holes.  
**403-00945**  
Angle Valve Stem. Fits .453" or .625" rim holes  
**289-41466**



**289-38772**  
**CHROME DOMES**  
Plain chrome tire valve stem caps.

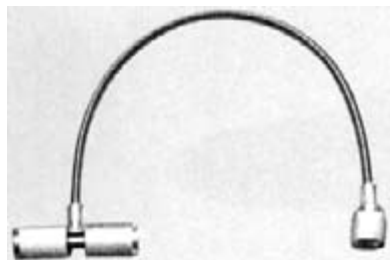

Valve fishing tool used while installing tire on rim.

**FLANDERS COMPANY**  
"CLASSIC SERVICE  
FOR  
OVER 60 YEARS."

INDEX

PAINT

HANDLEBARS

STREET LEVERS

FORK SEALS

CABLES

SUSPENSION

ELECTRICAL

FILTERS

BRAKE LINES

BRAKES

CABLE MAKING SUPPLIES

CONTROLS

DUAL SPORT

MANUALS

FSO PRODUCTS

EMGO

DRIVE

DISPLAY

JETS

BEARINGS

EYEWEAR

VINTAGE

MIRRORS

EUROPEAN

KICKERS

SHIFTERS

MISC

HARD PARTS

SHOP TOOLS

CHEMICALS

TOOLS

## Air Regulators & Filters

**289-56300**

Air line filter, uses 40 Micron element to remove water vapor, rust, dirt, etc. 1/4" NPT threads, 80 CFM at 100 PSI

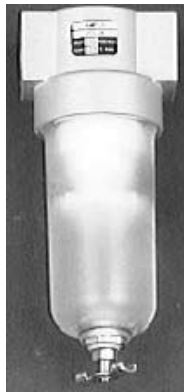

### Air pressure gauge

**289-11220**

0-160 PSI. 1 1/2" diameter dial, 1/8" NPT thread inlet. Thread underneath.



**289-56340**

Air pressure regulator. Controls full line pressure accurately. 1/4" NPT threads, 70 CFM at 100 PSI. Use 557-10121 gauge if needed

**557-01141**

Repair kit for above regulator



### Air line lubricator

**289-56320**

Automatically lubricates air tools. 1/4" NPT threads, 25 CFM at 100 PSI

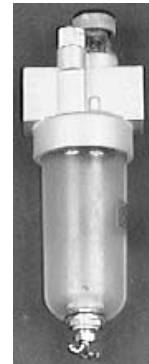

**Air pressure gauges. 2" dia. dial, 1/4" NPT thread**

**289-10121** 15 PSI.  
**289-10123** 160 PSI  
**289-11220** 300 PSI



### One pint air tool

**289-12200**

For pneumatic tools. Will not form varnish or sludge



INDEX

PAINT

HANDLEBARS

STREET LEVER

FORK SEALS

CABLES

SUSPENSION

ELECTRICAL

FILTERS

BRAKE LINES

BRAKES

CABLE MAKING SUPPL

CONTROLS

DUAL SPORT

MANUALS

F50 PRODUCTS

EMGO

DRIVE

DISPLAY

JETS

BEARINGS

EYEWEAR

VINTAGE

MIRRORS

EUROPEAN

KICKERS

SHIFTERS

MISC

HARD PARTS

SHOP TOOLS

CHEMICALS

TOOLS



INDEX

PAINT

HANDLEBARS

STREET LEVERS

FORK SEALS

CABLES

SUSPENSION

ELECTRICAL

FILTERS

BRAKE LINES

BRAKES

CABLE MAKING SUPPLIES

CONTROLS

DUAL SPORT

MANUALS

FSO PRODUCTS

EMGO

DRIVE

DISPLAY

JETS

BEARINGS

EYEWEAR

VINTAGE

MIRRORS

EUROPEAN

KICKERS

SHIFTERS

MISC

HARD PARTS

SHOP TOOLS

CHEMICALS

TOOLS

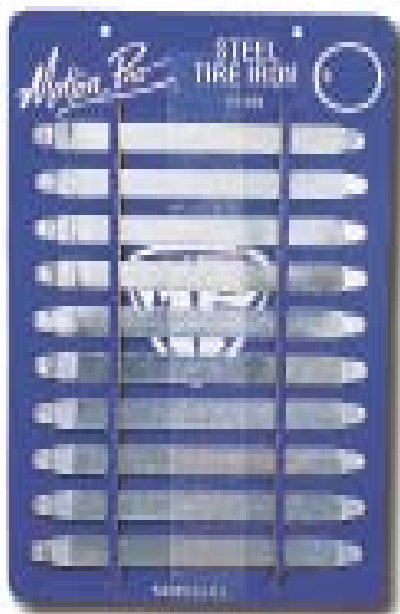

## 8.5" Steel Tire Irons

**121-08003 Sold each**

**121-08004 Card of 10**  
(order by card)

## 11.5" Steel Tire Irons

**121-08005 Sold each**

**121-08006 Display card of 2**  
irons (order by pair)

## Enduro Pro Tire Iron

**121-08051**

- Hot-forged chrome-vanadium tool steel
- Designed for the professional I.S.D.E. rider as well as any off-road motorcycle tool kit
- 8.5" long, 4.5oz.
- Slender curve
- Sold with a custom vinyl carrying pouch



## 121-08049 Assortment Tire Irons

- Skin-packed kit includes Motion Pro 8.5", 11.5" & 16" tire irons



## 16" Steel Tire Tool

**121-08007**

- Black-finished hardened alloy steel
- Double compound curved tire tool
- Sold each



## Spoon Tire Iron

**121-08115**

- Silver zinc finish
- Unique "spoon" shape
- Large curved end fits securely in the hand



Rev. 03-15-06

# Tire & Wheel Tools & Supplies

## Tire Irons



**151-01002**

Breezer tire changer designed to assist in removal and replacement of tire without damaging tube.



**121-08003**

Forged steel tire iron. Carry on the motorcycle size. 8 1/2" long. For a Display Card : Order 10



**121-08051**

Tire Irons. 8-1/2" long. Light weight hot forged chrome vanadium steel. This tool has a slender curve that exactly slides into the wheel rim and gentle taper for quickly getting under tire bead. With vinyl carrying pouch.



**121-08005**

Forged steel tire iron. For a bit more leverage than the "Carry On" size. 11-1/2" long.



**401-27915**

Forged steel 15" long tire iron. Shop size. Special bend for remounting tires.



**401-27916**

16 inch (400mm). Straight.



## Rim Locks - Tire Security Bolts

Part #	Rim	Tire size
401-26000	1.6"	(250-300 WM-1)
401-26010	1.85"	(325-350 WM-2)
401-26020	2.15"	(400-450 WM-3)
401-26030	2.75"	(500 + WM-4)

Rev. 03-15-06

INDEX

PAINT

HANDLEBARS

STREET LEVER

FORK SEALS

CABLES

SUSPENSION

ELECTRICAL

FILTERS

BRAKE LINES

BRAKES

CABLE MAKING SUPPL

CONTROLS

DUAL SPORT

MANUALS

FSO PRODUCTS

EMGO

DRIVE

DISPLAY

JETS

BEARINGS

EYEWEAR

VINTAGE

MIRRORS

EUROPEAN

KICKERS

SHIFTERS

MISC

HARD PARTS

SHOP TOOLS

CHEMICALS

TOOLS